

OKO<sub>ndt</sub> GROUP

EDDY-CURRENT SINGLE RAIL  
FLAW DETECTOR

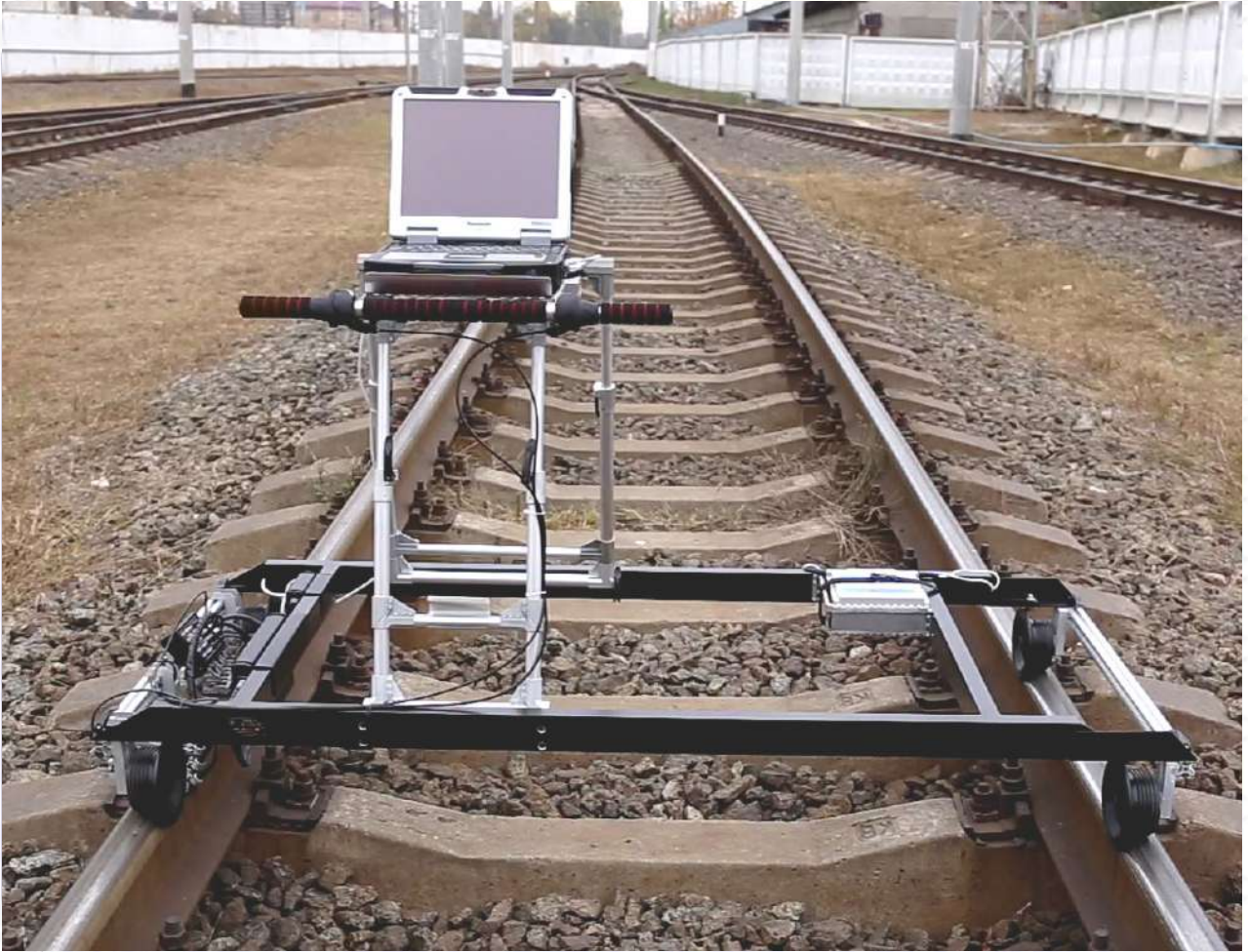

ETS2 - 77



- 1 **ETS2-77** eddy current single rail flaw detector is a mechanized scanner which is intended for manual eddy current inspection of rail head's active face and running surface of rails laid down in a track, for the presence of surface cracks. The flaw detector serves for detection of flaws, e.g. cracks in the rail head, as well as for evaluation of their depth.

The flaw detector is to be used for mechanized eddy current inspection of rails by railway infrastructure services.





The device allows detecting crosswise and oblique (at 45° to the longitudinal axis of rail) surface cracks of operational origin.

The flaw detector allows to estimate the depth of vertical defect to the active surface of the rail up to a depth of 3 mm.

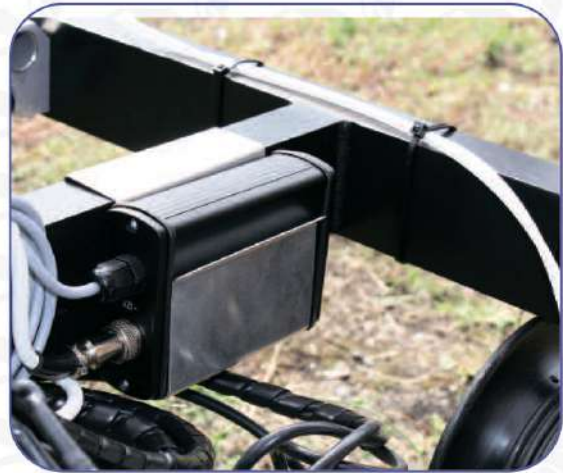

3

## Main components of ETS2-77 flaw detector are:

- Trolley of the flaw detector (incl. connecting cables and supporting wheels)
- Probe holder for inspection of the running surface of 49E1, UIC 60 and etc. rails
- Probe holder for inspection of the fillet of 49E1, UIC 60 and etc. rails
- EDDYCON D flaw detector
- Industrial laptop
- Battery
- Charger
- Reference block on a pad



## Eddycon D eddy-current flaw detector: 4

- Frequency: 10 Hz - 16 MHz
- Maximum output voltage: 20 V (peak-peak)
- Maximum allowable input signal: 2.0 V (peak-peak)
- Gain 1: 0 - 30 dB with a step of 0.1 dB
- Gain 2: 0 - 40 dB with a step of 0.1 dB
- Gain X: 0 - 30 dB with a step of 0.1 dB
- Gain Y: 0 - 30 dB with a step of 0.1 dB
  
- Phase setting: 0° - 359° with a step of 1°
- LowPass filter:  $F_{SMP. MAX}/2$  (1Hz to 11 kHz)
- HighPass filter:  $F_{SMP. MAX}/2$  (1Hz to 11 kHz)
- BandPass filter:  $F_{SMP. MAX}/2$  (1Hz to 11 kHz)
- Overall dimensions: 293 x 37 x 141 mm
- Weight: not more than 1kg
- Power: 12 V DC power

## Scanning modules with eddy current probes (ECP)

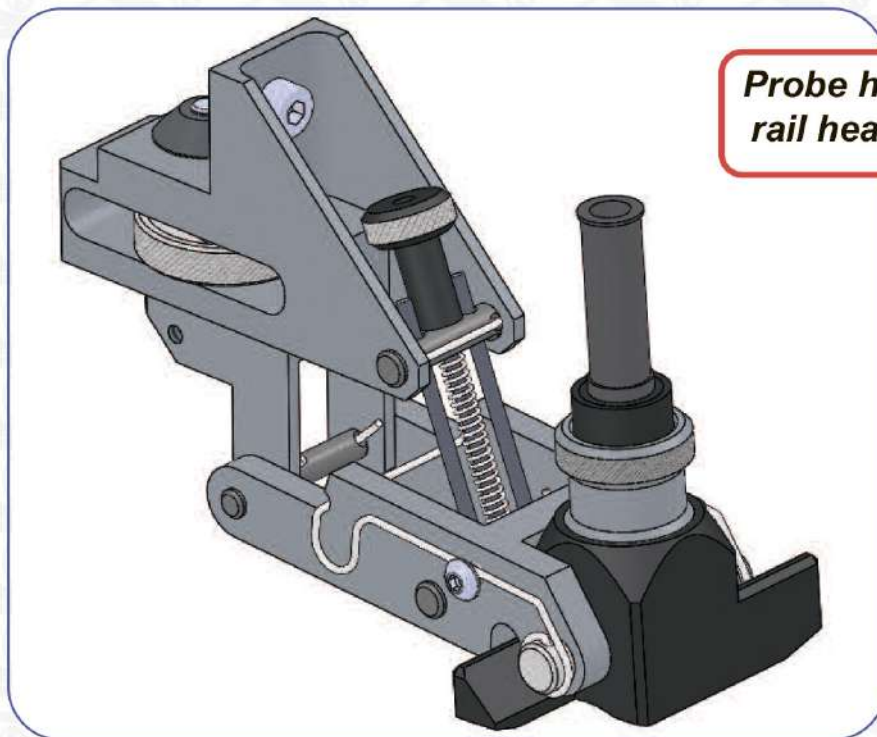

*Probe holder for rail head testing*



The ETS2-77 flaw detector is a folding structure, which can be transported as it is assembled in stowed position



**Arrangement of ETS2-77  
flaw detector  
in stowed position**

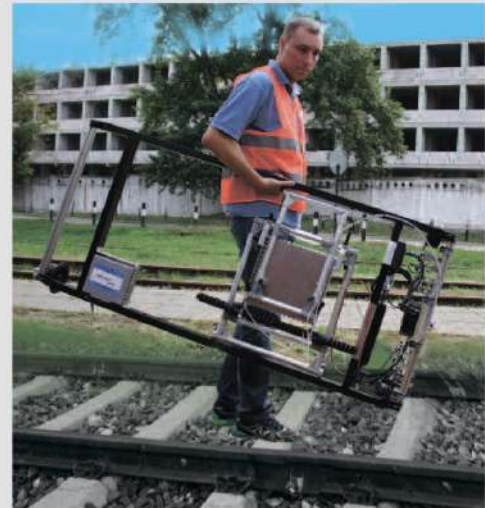

Weight of the assembled flaw detector does not exceed 22 kg.  
Overall dimensions of the assembled flaw detector  
are not more than: width - 900 mm;  
length - 1730 mm; height - 350 mm



## Laptop Panasonic CF-31 Toughbook\*



6

### Product specifications

- Operating System: Windows® 7 Professional available through downgrade rights in Windows® 10 Pro.
- Weight : 7.9 lbs
- Certification: MIL-STD-461F, MIL-STD-810G, IP65, ANSI 12.12.01-2000 Hazardous Locations.
- Battery: 18 hours (27 hours with optional media bay 2nd battery)
- Display :13.1" XGA 1200 nit touchscreen
- Durability: (Handset) Fully Rugged
- Ports & Expansions: USBx4, Optional FireWire, SDXC, Ethernet,
- Optional 2nd LAN (Ethernet), HDMI, VGA, Serial, Audio In, Audio
- Out, Mini-SIM, Dock Connector

\* Note. Type of laptop can be changed by manufacturer of flaw detector.



# Specially configured software RailEddy Program for setting up the EC channel

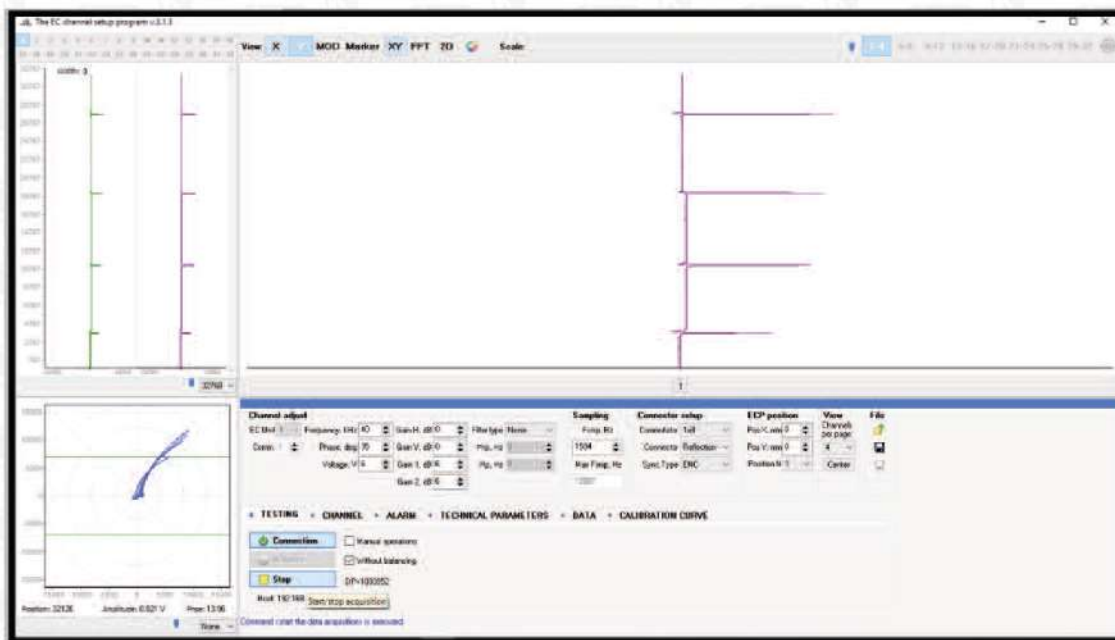

- Rapid set up of all EC channel parameters – EC probe frequency, generator output voltage, gain, filters, threshold level type, encoder, etc.
- Estimating the defect depth and length
- Four independent threshold levels for automated defect triggering (ALARM) for each displayed area
- Saving the testing setups into the PC memory

# Specially configured software RailEddy

## Program of testing

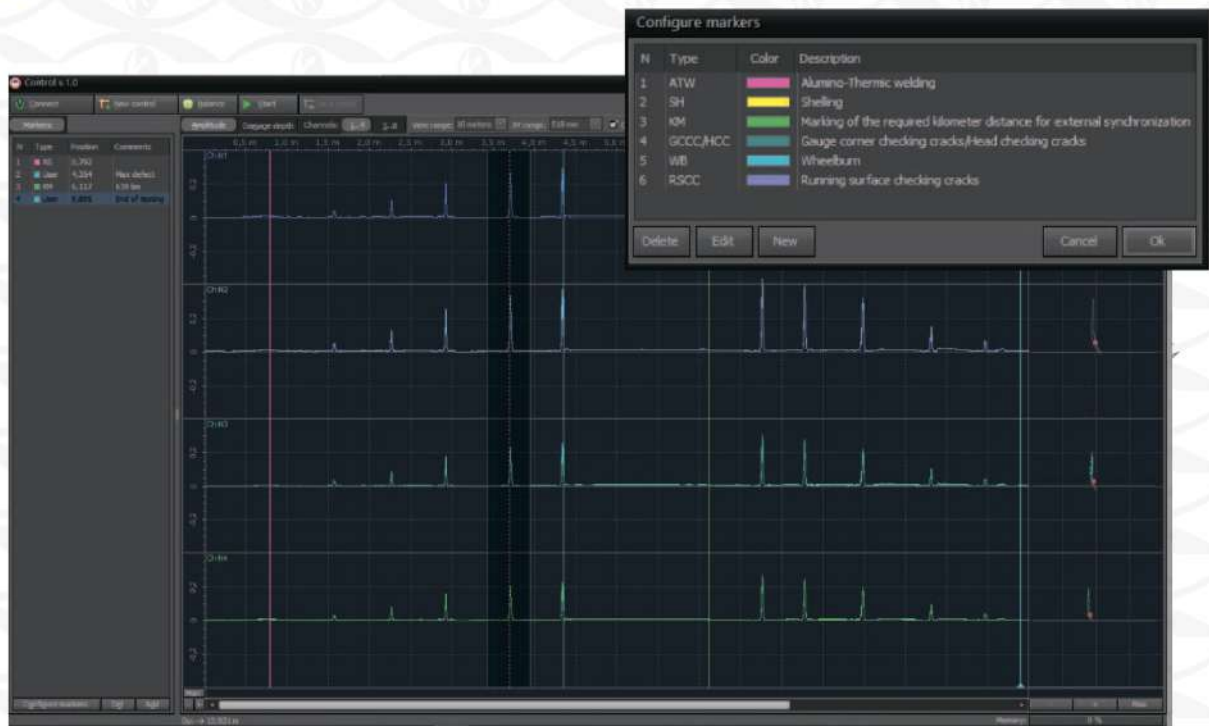

8

- EC probes per channel display
- Real-time display of EC probe information
- Recording the testing results into the PC memory
- Displaying different types of information in the signal visualization area
- Displayed for evaluating the signals on the obtained defectograms
- Re-calculation of the obtained defectograms

## Specially configured software RailEddy

*Program for generating the names of railroad*

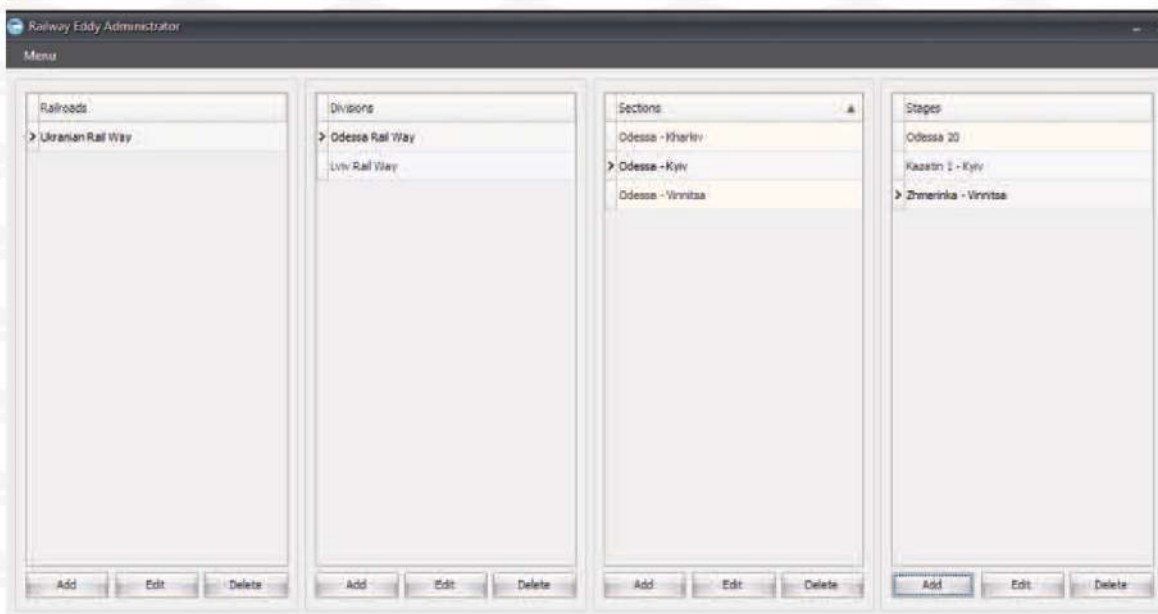

**Consists of the following components:  
Railroads – Divisions – Sectors – Stages**

## *Program for reviewing the testing results*

9



- Reviewing the testing results from the database, sorting and retrieval by various characteristics
- Printing out the test reports
- Archiving the testing results
- Reviewing the testing results from the remote PC etc.

# EDDY-CURRENT SINGLE RAIL FLAW DETECTOR

## ETS2 - 77



OKOndt GROUP

[www.okondt.com](http://www.okondt.com)

E-mail sales: [global-sales@oko-ndt.com](mailto:global-sales@oko-ndt.com)