

OKO_{ndt} GROUP

HIGH-SPEED RAIL TRACK
TESTING SYSTEM



OKOSCAN 73HS

OKOSCAN 73HS

System is specially designed for automated high-speed testing of rails in the railway track



OKOndt GROUP

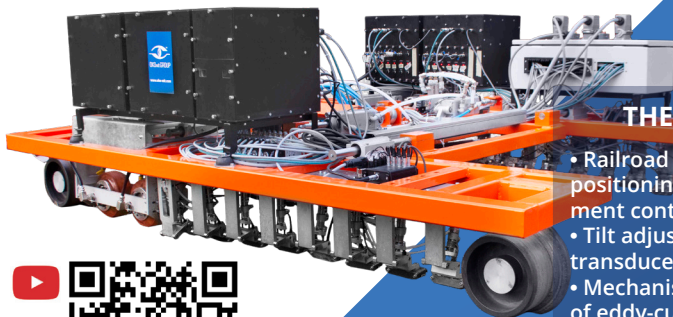

THE SYSTEM INCLUDES:

- Railroad wheeled trolley equipped with positioning system and track width adjustment control;
- Tilt adjustment control and immersion transducer units positioning system;
- Mechanism for installation and alignment of eddy-current probes with lifting/lowering mechanism;
- Ultrasonic rail test unit;
- Eddy-current rail test unit;
- Auxiliary equipment (a tank for coupling fluid equipped with a pump, level meters, pipelines and valves, air compressor);
- Hardware and software complex computer system;
- Complete kits of manual ultrasonic and eddy-current testing equipment for rails;
- Spare parts supply package;
- Technical documentation.



The OKOSCAN 73HS system of combined rail testing is designed for:

- ultrasonic (UT) and eddy-current (ECT) testing of railway track at a speed up to 40 km/h and detection of all the defects specified in the UIC 712 R (International Union of Railways Code of Rail Defects);
- measurement of defect parameters and saving the testing results in the database.

Flaw detection trolley

The trolley is a support steel structure with wheels, alignment system (pneumatics), trolley lifting and lowering mechanism (electric monorail hoist), positioning system of ultrasonic transducers and eddy-current probes and water supply system for transducers immersion units.

The flaw detection trolley provides for precise positioning and movement of ultrasonic transducers and eddy current probes. Pneumatic equipment mounted on the trolley is used for automatic adjustment of the trolley to the track width. Also, this equipment allows to ensure positioning of each transducer on its own tested area.

Main advantages of the trolley:

- capabilities of testing the curves with a radius of less than 200 meters;
- automatic positioning and alignment on the track;
- ease of maintenance;
- capability of controlling the suspension system.

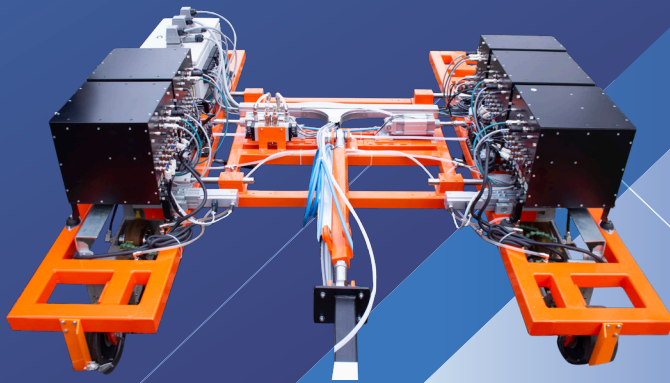

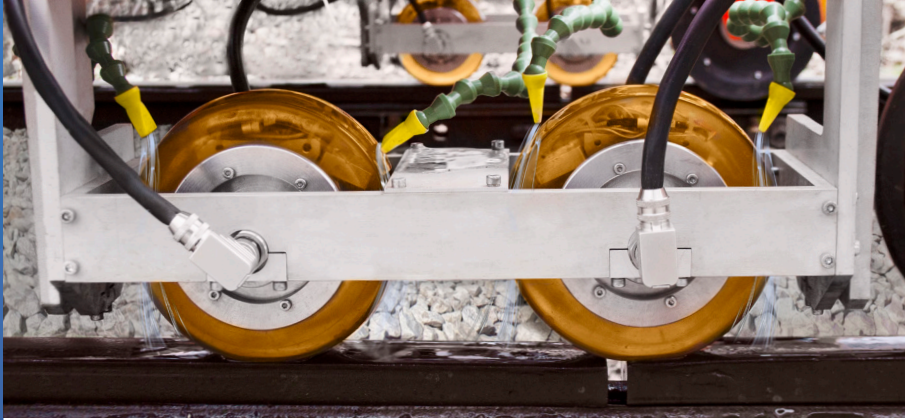

Ultrasonic rail test unit

Wheel probes

The ultrasonic rail testing System incorporates four (4) wheel probes. Each probe includes:

- three 70-degree transducers, 2 MHz
- one 50-degree transducer, 2 MHz
- one 37-degree transducer, 2 MHz (side looking)
- one 0-degree transducer, 4 MHz

Ultrasonic modules:

The OKOSCAN 73HS System utilizes OKO-24 single-channel ultrasonic modules with a frequency range from 1 to 7 MHz and initial pulse sending frequency of up to 4 kHz. The OKOSCAN 73HS structure envisages two positioning options of the ultrasonic modules:

1. Directly on the trolley. This positioning option provides for better protection against interference, wheel probe connection cables to the ultrasonic modules have a smaller length, data from the module to the PC are transferred through the Ethernet cable.

2. In the vehicle. This variant of positioning releases from an additional load and decreases the trolley weight, ultrasonic modules are protected from external climatic conditions impact.

Special-purpose software

The OKOSCAN 73HS high-speed rail flaw detector is supplied with the pre-installed software. The software is composed of:

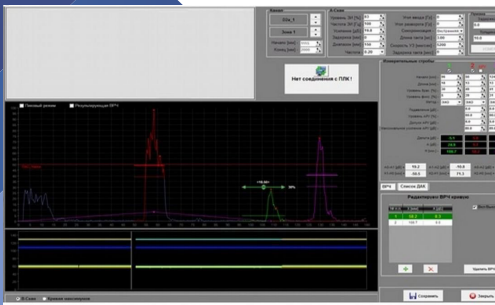

SW for the channel parameters setup

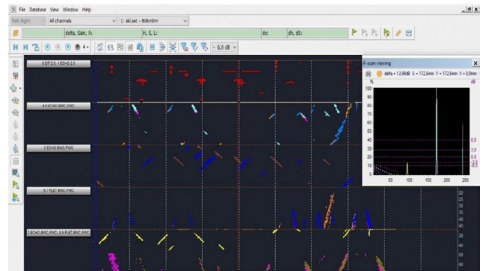

SW for testing, review and analysis of the test results.

Eddy Current Probes

The eddy-current test unit consists of

- eddy-current probes - 16 pcs;
- switches - 2 pcs;
- Eddycon D eddy-current flaw detectors - 2 pcs;
- track gauge (traveled distance sensor) - 1 pc;
- PC with preinstalled software - 1 set.

The eddy-current unit of the system provides for eddy-current inspection of the gauge corner and rolling surface head for the following types of defects:

- transverse fatigue cracks and headchecks (defect code UIC-211),
- quench cracks (defect code UIC-2223),
- wheel slippage area (defect code UIC-225).



OKOndt GROUP

High-speed eddy current system for rails testing OKOSCAN ET 73HS is equipped with sixteen eddy-current probes (ECP) - eight for each rail.

Features and technical specifications of ECP used in the system:

- the central operating frequency is 200 kHz,
- orientation of the detected defects - transverse, at an angle relatively to the rail axis,
- use of fixing bogies made of wear-resistant material,
- individual suspension bracket for each bogie to unambiguously position the probes on various rail profiles,
- gap between the body of ECP and the rail surface to prevent mechanical damage of the probes.

All the ECPs are positioned on the rails so that 100% testing of the gauge corner and the rolling surface is ensured.

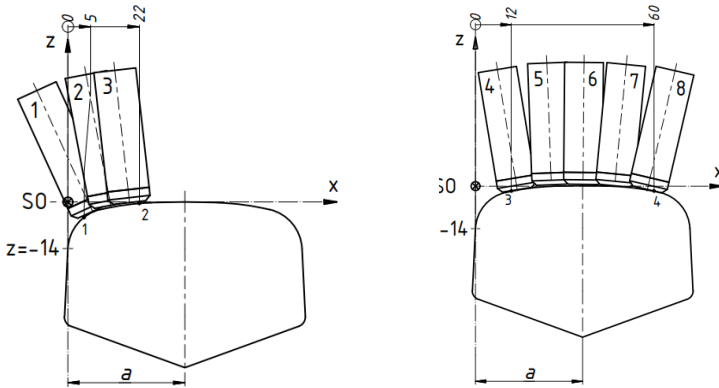

Eddy Current Flaw Detectors

High-speed eddy current system for rails testing OKOSCAN ET 73HS is equipped with two multi-channel eddy-current flaw detectors Eddycon D. OKOSCAN ET 73HS design provides for the capability to install the flaw detectors both on the flaw detector trolley and in the cab of the rail road vehicle.

Specialized Software

High-speed eddy current system for rails testing OKOSCAN ET 73HS is supplied with pre-installed software that consists of:

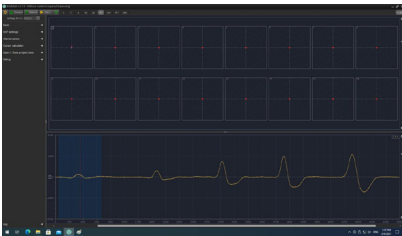

Software for setting up the flaw detectors

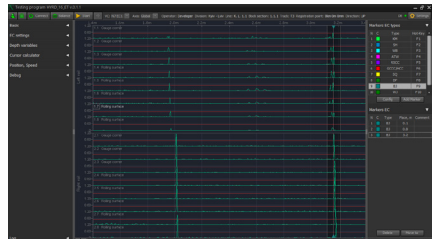

Software for testing and analysis of the current data

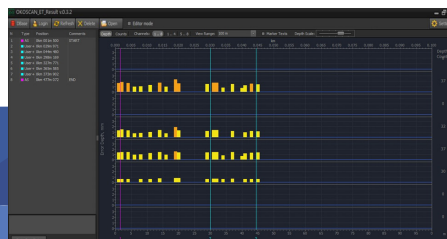

Software for viewing the testing results

Main technical specifications of the system
Detection efficiency parameters
Parameters of tested areas and of the flaws detection efficiency

Name	Value
Close dead area	Crystal current probe 00 : 8 mm; Crystal current probe 400 : 5 mm); Crystal current probe 700 : 3 mm; Crystal current probe (CCP) 550 - 5 mm; ECP - none.
Tested Area	Ultrasonic testing: Crystal current probe 00 : full rail height; Crystal current probe 400 : full rail height; Crystal current probe 700 : rail head Crystal current probe 550 - rail head; Eddy Current Inspection: 5 ECP - rail rolling surface; 3 ECP - rail gauge corner;
Resolution with references to the coordinates - Longitudinal coordinate - Depth - Rail height;	1.0 mm; 0.1 mm; 0.1 mm
Assessment of the cracks vertical component depth by eddy- current method	from 0.7 mm to 3 mm
Accuracy of determining the parameters during ultrasonic testing: - Depth - Rail height;	± 0.5 mm ± 0.5 mm
GPS	Recording the global positioning coordinate in the control file and then viewing it on a computer
Minimally detectable defects	Ultrasonic testing (at a 2 mm sonic test pitch) Cylindrical hole of 2 mm diameter in the rail head 5 mm deep and 1.5 mm wide groove in the working edge of the rail head (or 5 mm diameter flat bottom hole in the working edge), transverse crack simulation. 5 mm deep, 2 mm wide groove in the rail base, corrosion simulation Eddy Current Inspection: 1.2 mm deep "cut" is made on the running surface in the sectional plane

Parameters of Ultrasonic and Eddy Current Parts of the System

Name	Value
System configuration	<p>Each OKO-24 UT channel can process the signals from 1 to 8 crystal current probes. The number of probes and system configuration depends on the Customer's requirements.</p> <p>Each Eddycon D channel can process the signals from 1 to 32 ECPs. The number of transducers and configuration depends on the Customer's requirements</p>
Test Methods (ultrasonic)	Echo method, reflection-shadow method
Number of channels in OKOSCAN UT / ET 73 HS system	<p>Ultrasonic testing: 12 channels per rail (two immersion transducer units): Crystal current probe 00 : 1 pc Crystal current probe 400 : 2 pcs.; Crystal current probe 700 : 6 pcs.; Crystal current probe 550 (Side Looking) : 2 pcs.</p> <p>Eddy Current Testing: 1 flaw detector+1 switch board per one rail: ECP - 8 pcs.</p>
Sonic test pitch	From 1 mm to 10 mm
Testing speed	<p>Ultrasonic testing Up to 40 km/h – at a 3 mm sonic test pitch. Up to 30 km/h - at a 2 mm sonic test pitch. Up to 15 km/h - 1 mm sonic test pitch.</p> <p>Eddy Current Testing: Up to 40 km/h - a sonic test pitch is 1 mm.</p>
Types of tested rails	P45, P50, P65, UIC60, S49, E60
Inspection Report Display	UT: A-scan, B-scan (on all the channels); EDC: Time scale (on all the channels)
Data communications protocol between PC and PLC.	Ethernet



OKO_{ndt} GROUP



OKOndt GROUP

www.okondt.com

E-mail sales: sales@okondt.com